

FIG. 4

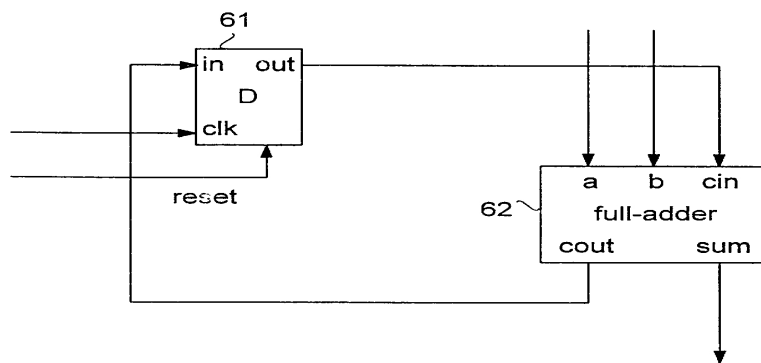

FIG. 6